

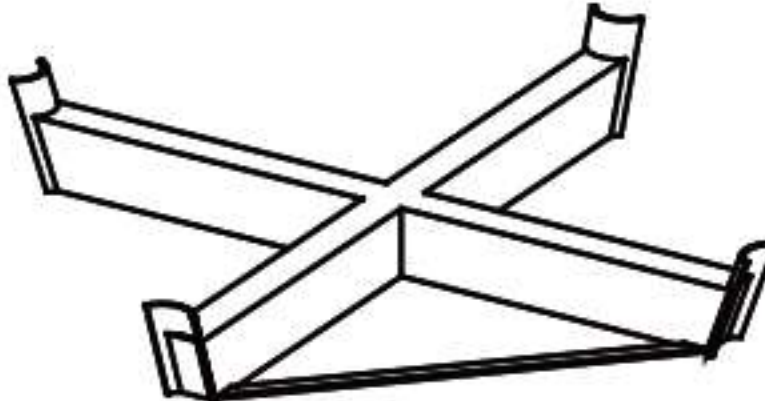

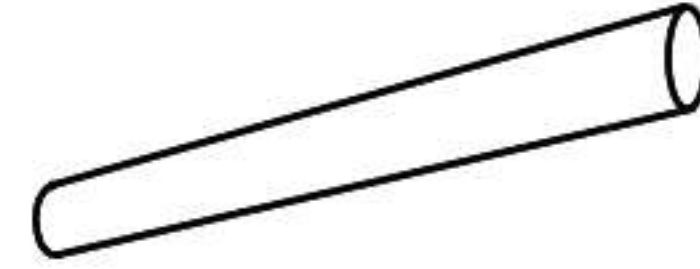



- | | | |
|---|---|----|
| A |  | x1 |
| B |  | x4 |
| C |  | x1 |
| D |  | x8 |
| E |  | x4 |
| F |  | x1 |
| G |  | x4 |



1

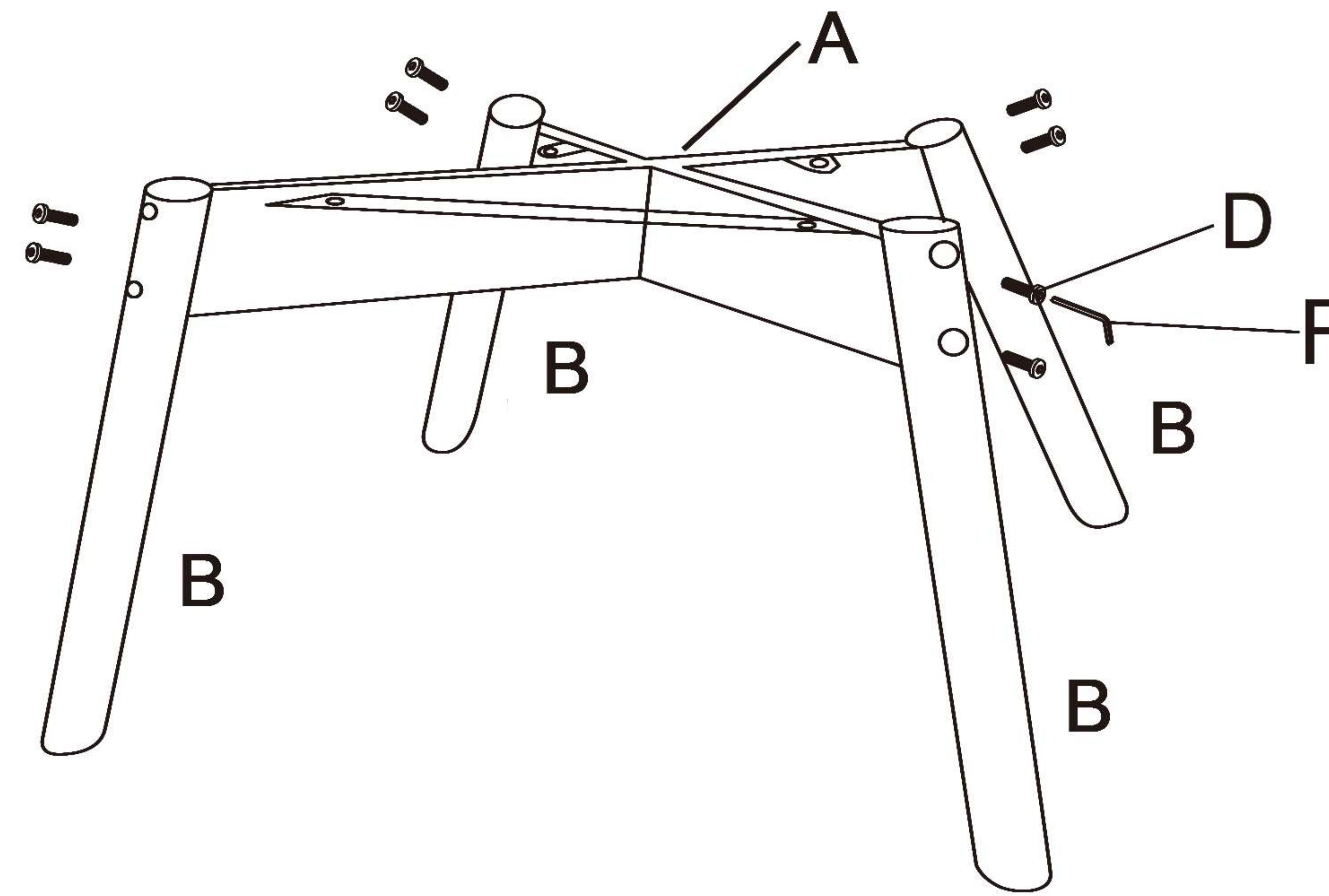
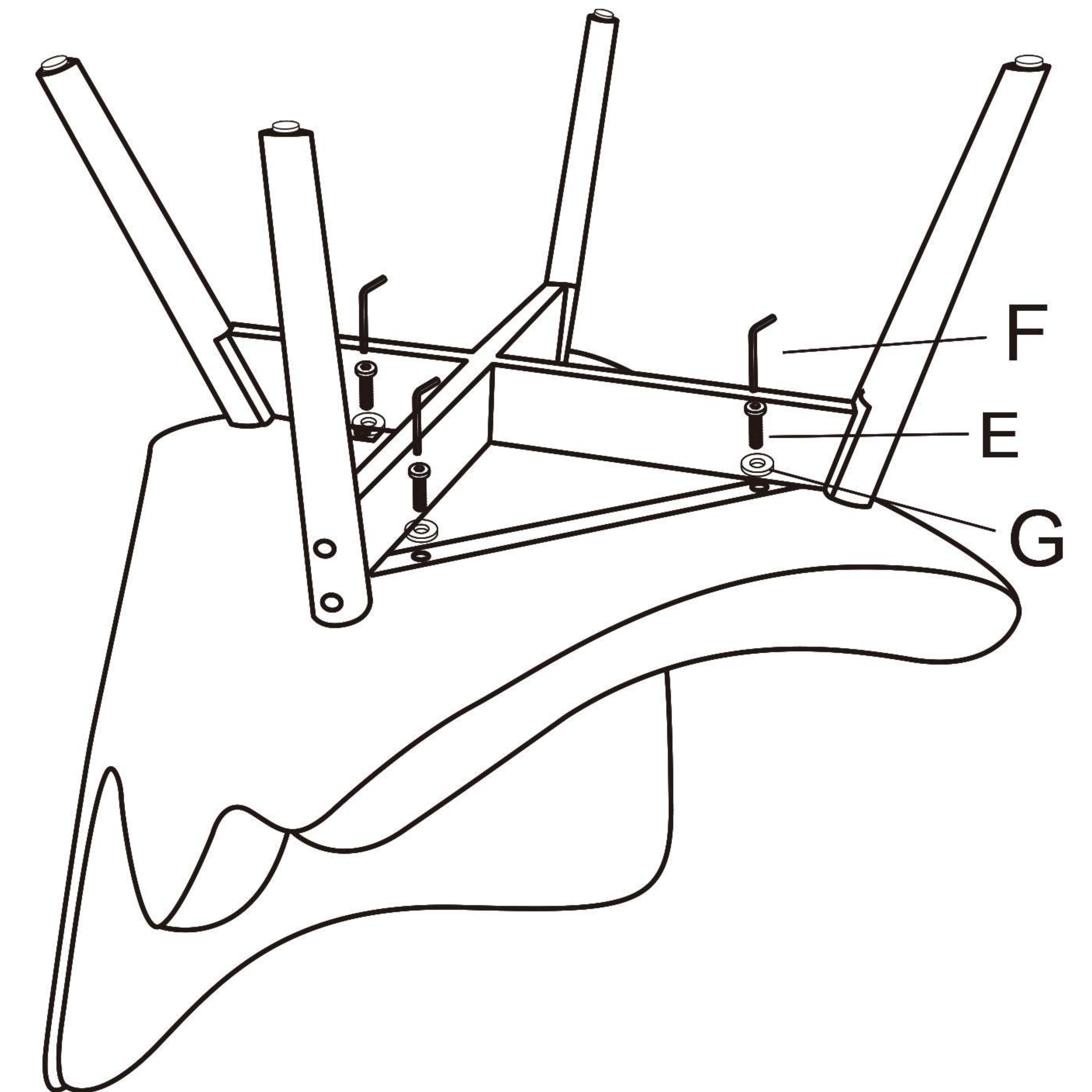

2

- Remarque : Positionnez d'abord les vis à la main, et à la fin du montage, vissez les bien avec les outils.
- Note: First, place the screws by hand and at the end of the assembly, fasten them firmly with tools.
- Observación: Fije primero los tornillos a mano y al final del montaje, atornillarlos firmemente con herramientas.
- Anmerkung: Bringen Sie zuerst die Schrauben von Hand an und drehen Sie sie mit den Werkzeugen am Ende hinein.